

PIEZOSURGERY® 3 - accessoires

LOT 03230006
PHYSIODISPENSEUR
(50 PCS.)

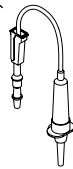

01380002
TIGE PORTE POCHE
SOLUTION PHYSIO

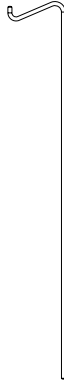

02900040-001
SUPPORT DE LA
PIÈCE À MAIN

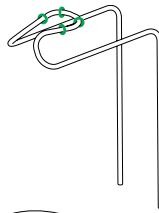

00050030
CÂBLE D'ALIMENTATION IT
00050002
CÂBLE D'ALIMENTATION
SCHUKO
00050032
CÂBLE D'ALIMENTATION
SUISS

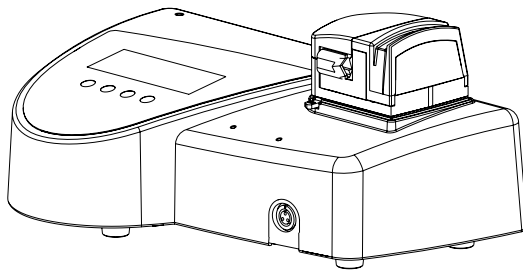
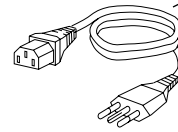

02900039-001
KIT 8 TUBE POMPE (PIÈCE À MAIN AVEC
CONNECTEUR CORDON EN METAL)
02900104-001
KIT 8X PUMP TUBE (PIÈCE À MAIN AVEC
CONNECTEUR CORDON EN PLASTIQUE)

SN 03120023-001
PIÈCE À MAIN COMPLÈTE
AVEC CORDON

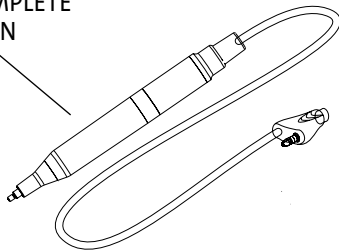

LOT 02900109-001
CLÉ DE SERRAGE K8

02900111
RADEL INSERT BOX
(15 INSERTS)

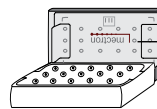

02900037-001
PORTE-INSERTS
(5 INSERTS)



04440007-001
VALISE

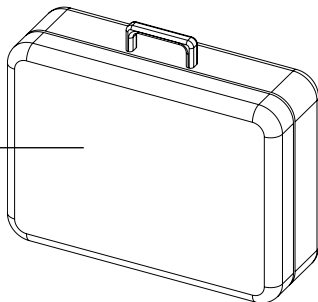

04610004-001
CASSETTE DE
STÉRILISATION

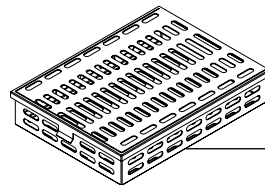

LOT 02900078-001
PÉDALE DE COMMANDE

